

# High Quality RUBBER TRACKS



## High Quality **HiQual** RUBBER TRACKS

Toll Free 1-866-440-8844

[sales@hiqualtrack.com](mailto:sales@hiqualtrack.com)

**Multi Terrain Loaders**



Patent:  
US 7,533,945 B2

**Skid Steer Loaders**



**Non-Metal Core!**



**S'Wave**

**S'Wave Smooth Ride!**



**Good Wear!**

**SWN Good Traction!**



**ASN**

**Mini Skid Steer Loaders**

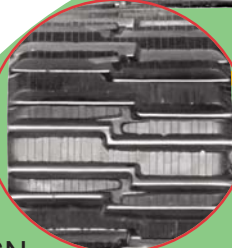

**Aramid Cords!**

**S'Wave**



**Quad Track**

**Toro Track**



**SWA**



**DBT**



**DogBone**

**S'Wave**

**Mini Excavators**



**ARB**



**TNA**



**Track Pads**



- **High Quality!**
- **OEM Vendor!**
- **Best Warranty!**
- **Immediate Delivery!**

(F) 630-351-0779



SRJ, Inc. 2242 Palmer Drive, Schaumburg, IL 60173

# HiQual RUBBER TRACKS



SRJ, Inc.  
Schaumburg, IL & Carson, CA  
Tel: 866-440-8844 Fax: 630-351-0779  
email: woodyjee@srjinc.com



## Tread Patterns

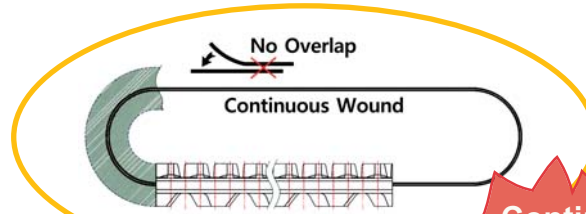
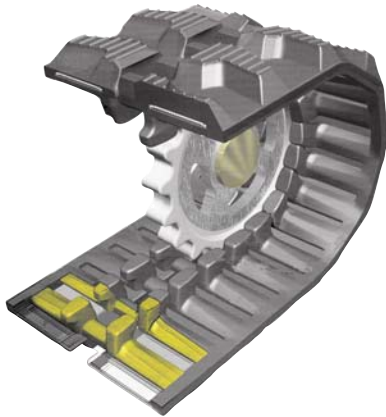
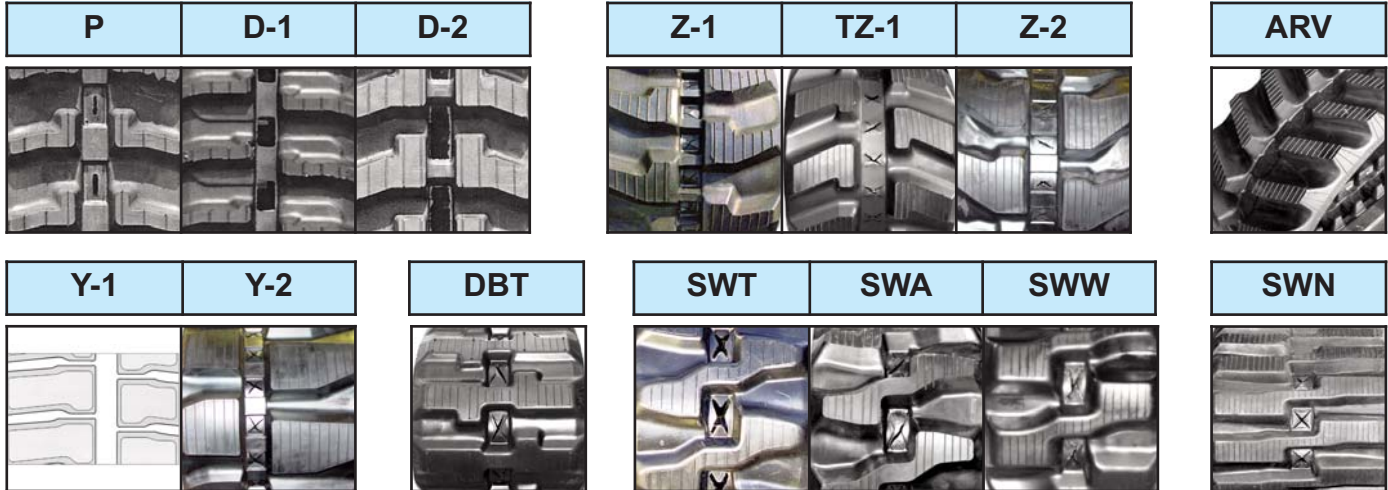

**NO Overlap Cords!**

**Continuous Wound Steel Cords!**

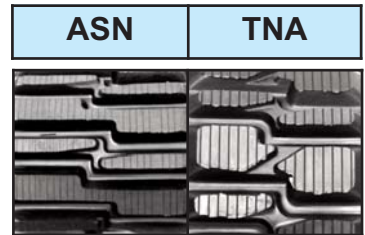

## Request for Price Quotes:

Machine Make & Model:

Make	
Model	

Wheel Guide Type:

**Fax To: Sales Technician**

**Fax No.: 630-351-0779**

Track Size:

Track Width (W)	
No. of Links (L)	
Pitch Distance (P)	
I.G.B.	
O.G.B.	

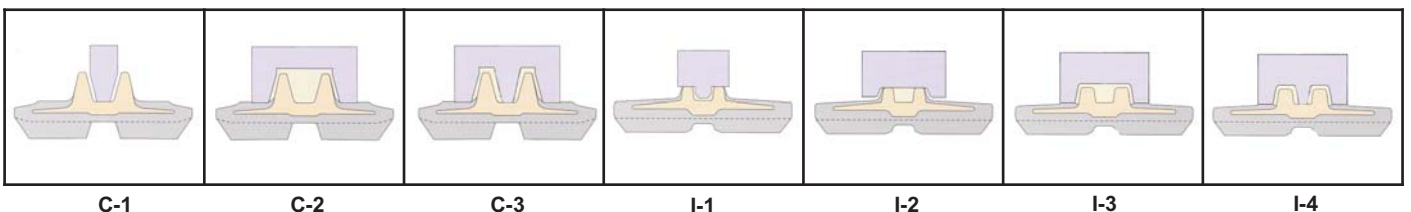
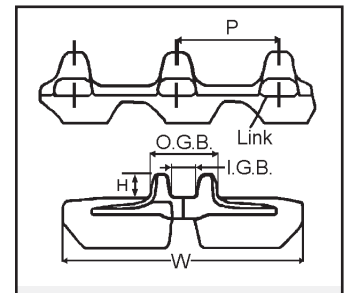

SRJ, Inc. 2242 Palmer Drive, Schaumburg, IL 60173



High Quality **HiQual**



SRJ, INC.  
Schaumburg, IL & Carson, CA  
Tel: 866-440-8844 Fax: 630-351-0779  
email: sales@hiqualtrack.com

# RUBBER TRACKS

## Why is HiQual Track Superior?



1.

### Unique Design



US Patent 7,533,945 B2

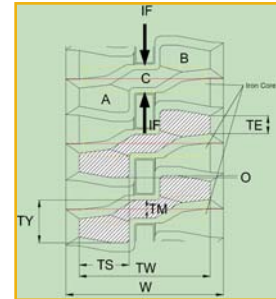

1. One Tread Lug per Iron Core
2. Continuous Ground Contact
3. Each Tread Lug: Solid S'Wave Solid Bar Style

Meaning

**Smooth Ride! Good Traction! Good Wear!**

Compared to Other Wide & C-Pattern Style,



450x55x86SWB

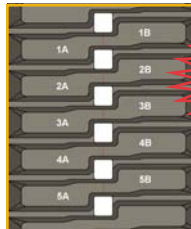

S'Wave

Each Tread Lug **Independently** Sprocket Engaged

$$1A + 1B \geq 1C$$

$$1A + 1B > 1D \text{ by } 3\%$$

Meaning

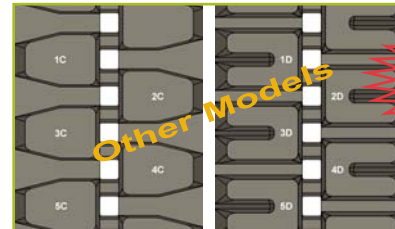

Wide

C-Pattern

Each Tread Lug **Interactively** Sprocket Engaged

S'Wave ground contact is equal to or slightly over Wide pattern and greater than C pattern by 3%.



Track Mark

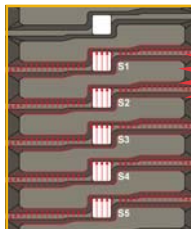

S'Wave

Each Tread Lug **Independently** Sprocket Engaged

$$S1 > W1 \text{ by } 21\%$$

$$S1 > C1 \text{ by } 36\%$$

Meaning

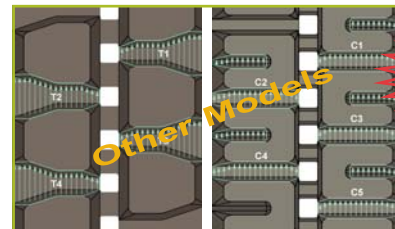

Wide

C-Pattern

Each Tread Lug **Interactively** Sprocket Engaged

S'Wave has more traction than Wide pattern by 21% and C pattern by 36%



2.

### Patented Anti-Vibration System

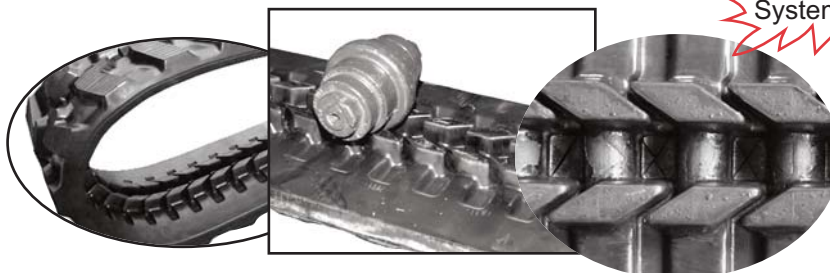

Patented AVRT System!

VS

Compare to this conventional and bumpy ride style!



Conventional Style

IL Warehouse:

2242 Palmer Drive, Schaumburg, IL 60173

CA Warehouse:

1130 E. Watson Center Rd., Carson, CA 90745

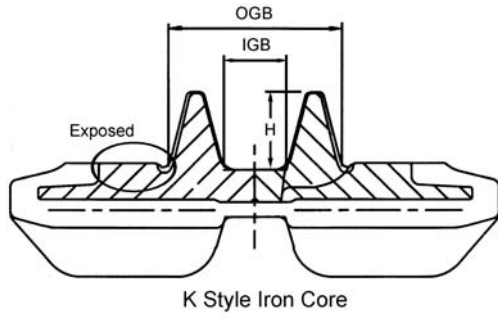
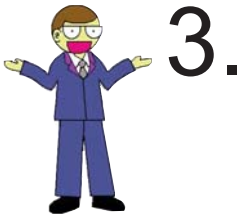

**K-Style Iron Core**

180x72SWK  
 230x72SWK

*For Higher Payload M/C!*

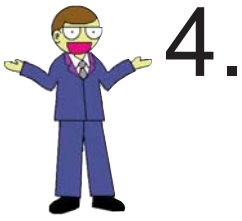

**Thick Body Carcass (CT)**

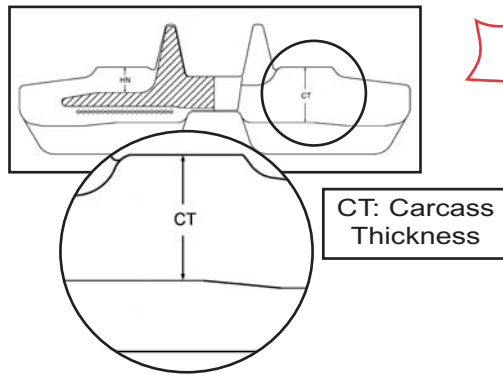

**Thick Body Carcass**

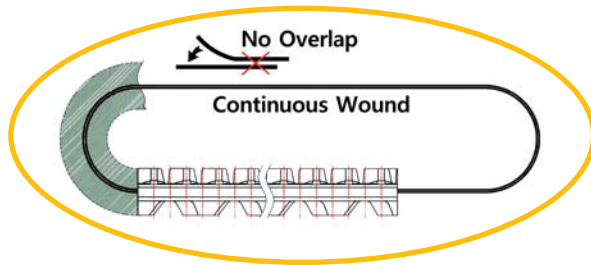
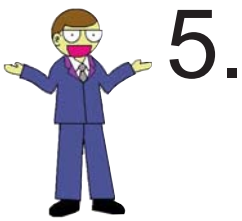
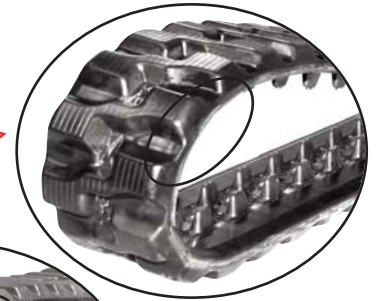

**Continuous Wound Steel Or Aramid Cords!**

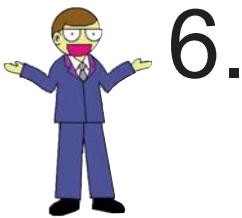

**Non-Metal Core Tracks**

**German-made Aramid Cords!**

**Equivalent To Kevlar Cords**

**WE DO NOT USE CHEAP STRETCHABLE PE CORDS.**



**IL Warehouse:**

2242 Palmer Drive, Schaumburg, IL 60173

**CA Warehouse:**

1130 E. Watson Center Rd., Carson, CA 90745



**LIMITED PRODUCT WARRANTY**  
**Rubber Track: HiQual, S'Wave**  
**SRJ, Inc.**



**A. General Provisions:** This warranty is provided by SRJ, Inc., 2242 Palmer Drive, Schaumburg, IL 60173 ("SRJ"), to the original purchaser ("You") of a track with brand, HiQual or S'Wave or any other brand(s) ("SRJ Track"), which SRJ or its authorized representative or distributor ("Authorized Seller") sold. Warranty service must be processed through SRJ or Authorized Seller. Warranty coverage will be without charge to you except as provided in this Warranty Policy. However, you may be responsible for transportation to SRJ or Authorized Seller (except where prohibited by law).

**B. Proof of Purchase:** This warranty is subject to a proper registration completed by you and on file with SRJ at the time of any claim or sufficient proof of purchase.

**C. Warranty:** SRJ is proud to warrant to you that any SRJ Track(s) will be free of any defective in material or workmanship on all SRJ Track(s) during this applicable warranty term:

<i>EQUIPMENT</i>	<i>WARRANTY PERIOD</i>	<i>REMARKS</i>
Mini Excavators	1,500 hours or 12 months from the purchase date, whichever comes first	Replacement or Refund of Purchase Price as elected by SRJ
Skid Steer Track Loaders	1,000 hours or 12 months from the purchase date, whichever comes first	A Prorated Amount Reduction by 25% for each 250 hours or 3 Months of Use. Replacement or Refund of Purchase Price as elected by SRJ
Other Type of Equipment	1,500 hours or 12 months from the purchase date, whichever comes first	Replacement or Refund of Purchase Price as elected by SRJ

**D. What is NOT Covered:** SRJ is not responsible for SRJ Tracks that have been altered or modified or damaged by improper and/or wrong installation or for normal wear or abrasion, overloading, fire or excess heat, ambient conditions by oil and chemical contact, lack of reasonable and proper maintenance, cuts, snags, tears, misuse, vandalism, collision or accident, use in competitive activities, abuse, or any disastrous circumstances such as frost, flood, war and strikes. This warranty is not transferable and applied only to you, the original purchaser of the SRJ Track.

**E. Obtaining Warranty Service:** To obtain warranty service you must (i) promptly report the defect to SRJ or an Authorized Seller and request warranty service; (ii) have properly registered the SRJ Track(s) or present valid proof of purchase; and (iii) cooperate with SRJ in processing the claim. To proceed the claim, SRJ may require that you deliver the subject SRJ Track(s) to the facility of SRJ or an Authorized Seller, at your cost, within a reasonable period of time after discovery of the defect and for a reasonable time in order to allow inspection of the SRJ Track(s). SRJ may also elect to examine the SRJ Track(s) at your site or may request digital pictures from you of the same.

**F. Limitations:** To the extent permitted by law, neither SRJ nor any Authorized Seller or employee or company affiliated therewith make or has any authority to make any warranty, representation, condition or promise, express or implied, verbal or otherwise, as to the quality, performance or freedom from defect or to modify this warranty in any way except as stated herein. NO IMPLIED OR STATUTORY CONDITIONS OR WARRANTIES OF MERCHANTABILITY OR FITNESS ARE MADE. IN NO EVENT WILL SRJ OR ANY AUTHORIZED SELLER OR AFFILIATE BE LIABLE FOR ANY INCIDENTAL OR CONSEQUENTIAL DAMAGES OR INJURIES, INCLUDING, BUT NOT LIMITED TO LOSS OF PROFITS, RENTAL OF SUBSTITUTE EQUIPMENT, OTHER COMMERCIAL OR PERSONAL LOSS OR DAMAGES OF ANY KIND OR NATURE ARISING OUT OF A BREACH OF THE WARRANTY DESCRIBED HEREIN AND YOU SPECIFICALLY WAIVE THE SAME. This is the only warranty made by SRJ to you. The remedies in this warranty are the sole and exclusive remedies that you have and you waive any others. This warranty gives you specific legal rights, however you also may have other rights which vary from state to state and some states may not allow the exclusion or limitation of incidental or consequential damages or other portions of this warranty.